



ITT

Commercial Water

Goulds Pumps

AquaForce™ PRESSURE BOOSTING SIZING GUIDE Building and Municipal Applications



Goulds Pumps is a brand of ITT Corporation.

www.goulds.com

Engineered for life



AquaForce GENERAL INFORMATION

The AquaForce pump station is provided as a pre-engineered answer for installations requiring consistent water pressure with variable flow rates. The AquaForce can be selected and installed for many applications including: hotels, commercial buildings, public buildings, schools, hospitals, domestic water, irrigation, general industrial process, municipal water supply, rural water supply, RO water, wash systems and general water boosting. Each of these applications typically sees varying demand during the day, but the users demand a consistent water pressure even in periods of peak use.

Goulds Pumps has developed the AquaForce pump station to meet this need. The AquaForce consists of either two (duplex) or three (triplex) pumps mounted to a common steel base. These pumps may be either horizontal end suction or vertical multistage design based on the required pressure. Pump liquid end components and the common suction and discharge manifolds are all provided in stainless steel. Each station also includes all required

gate valves, check valves, pressure transducers and gages.

Each pump is equipped with its own Aquavar variable speed pump controller, which is described in more detail in the following section. A central fuse panel with individual pump disconnects is provided to assist with shut down for maintenance. The entire AquaForce station carries the UL and CUL certification for control panels and complete pumping systems.

The AquaForce can be connected to either surface or underground supply tanks or directly to municipal water supply. The following diagram shows the various piping layouts available for both duplex and triplex pump stations. Both suction and discharge manifolds are supplied with flanges at each end for either left hand or right hand installation.

NOTE: Each pump in the AquaForce station is sized with the same maximum flow rate. For duplex stations, each pump can produce 50% of total flow. Same sized pumps are used for duplex or triplex.

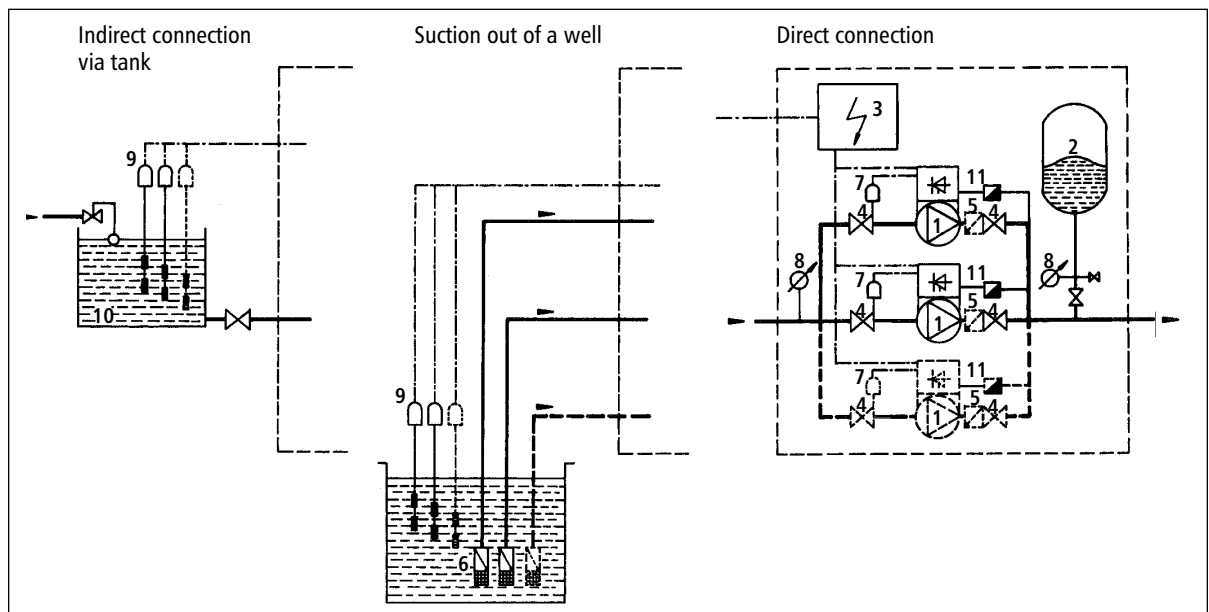

- | | | |
|--------------------------------|----------------------------|-------------------------|
| 1 Pump with AQUAVAR controller | 4 Gate valves | 8 Pressure gauges |
| 2 Diaphragm tank | 5 Check valves | 9 Level switches |
| 3 Distribution panel | 6 Foot valves | 10 Supply tank |
| | 7 Incoming pressure switch | 11 Pressure Transmitter |



ITT

GOULDS PUMPS
Commercial Water

COMMON APPLICATIONS

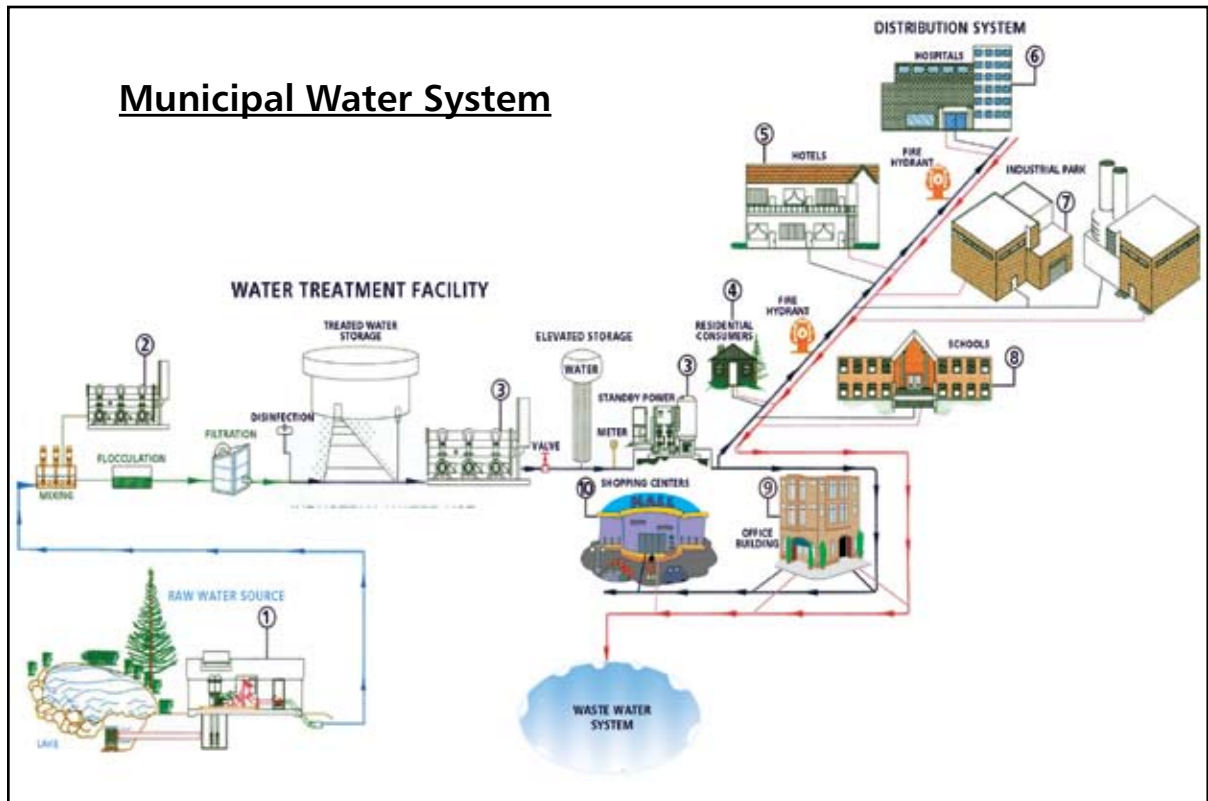

TYPICAL G&L PUMPS PRODUCT

Applications	AquaForce	AquaBoost	Aquavar	Turbine	SSV	SSH	SMVT	MPVN
1 Raw Water Pumping				X			X	X
2 Industrial Source Water	X		X	X	X	X	X	X
3 Municipal Booster Station	X		X	X	X	X	X	X
4 Residential Booster		X						
5 Hotel Water Boost	X		X		X	X	X	X
6 Hospital Water Boost	X		X		X	X		
7 Industrial Water Boost	X		X	X	X	X	X	X
8 Schools Water Boost	X		X		X	X		
9 Office Buildings	X		X	X	X	X	X	X
10 Shopping Centers	X	X	X		X	X		



WATER SUPPLY SOURCES AND CONNECTIONS

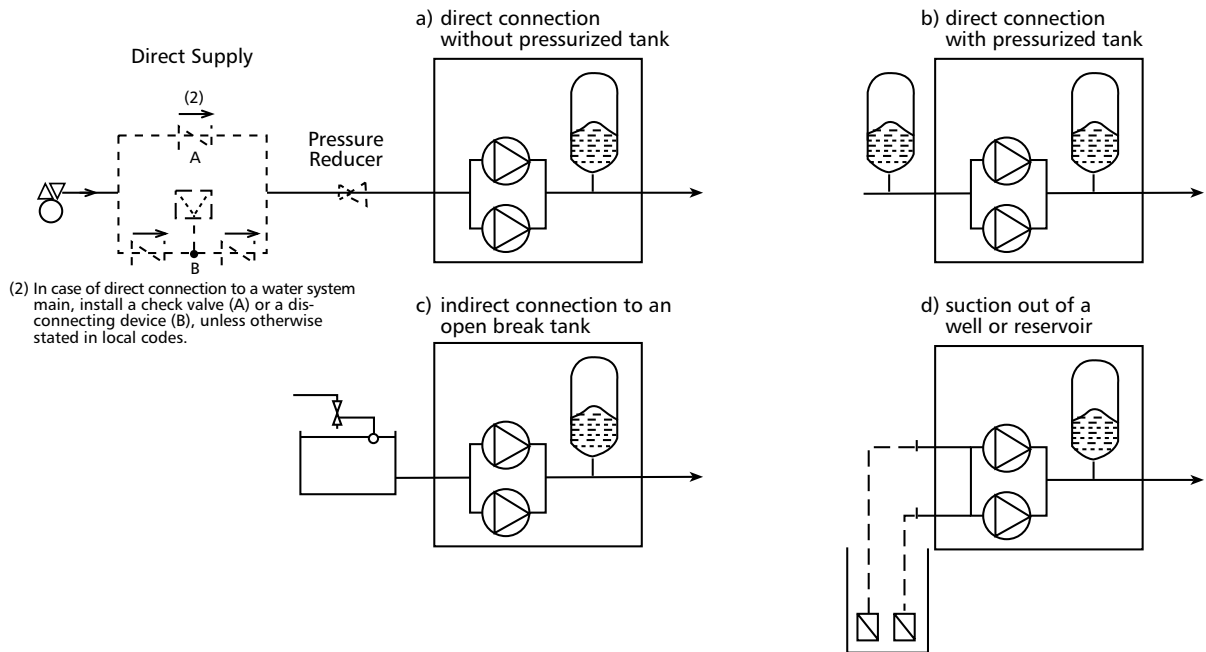

- a.) **Direct Connection** – Booster stations or pumps may be connected directly to the main line water supply if there is adequate provision to prevent back flush of water from the booster back into the main line. Check valves and anti-syphon valves may be used for this purpose. Check with local regulations for the level of protection required. In some cases the use of a variable speed pump, which eliminates hard starts and water hammer, will allow direct connection.
- b.) **Direct Connection with Pressurized Tank** – Some water supply systems are already equipped with a pressure tank, but the change in demand during the day may cause the pressure to drop below an acceptable level. In these cases, a booster pump or station may be used to pressurize the line. This is a common application when filtration is performed on incoming water before use.

- c.) **Indirect Connection to an Open Tank** – The water supply may be routed into an open accumulation tank prior to being pressurized for use. The tank is filled on demand with a float switch and valve and the pumps are under positive suction. This type of connection may be needed in some municipalities which restrict direct main line connection.
- d.) **Boosting from a Well or Reservoir** – In general, booster pumps and pump station may be designed to lift water from a shallow well or reservoir. Care needs to be taken to match the pump NPSH requirements to what is available. Typically each pump has its own supply pipe with a foot valve.

NOTE: A diaphragm or bladder tank is recommended for the complete system. This tank must be supplied by the Goulds Pumps distributor and is not supplied by the factory.



COMMON DESIGNS FOR BUILDING BOOSTER SYSTEMS

Water supply boosting for multi-story buildings can take many different configurations depending on the availability of main line pressure, the height of the building and the size of the booster unit.

In general, water pressure in a residential or commercial building should not fall below 20 psi at the point of use. When pressures drop below this point, common appliances

and plumbing fixtures will no longer function properly.

At the most favorable point of use, the pressure should not exceed 70 psi. Pressures beyond this may lead to failure of piping joints, fixtures and appliances.

The following diagrams show six common configurations of main line and booster pressure use to meet these requirements.

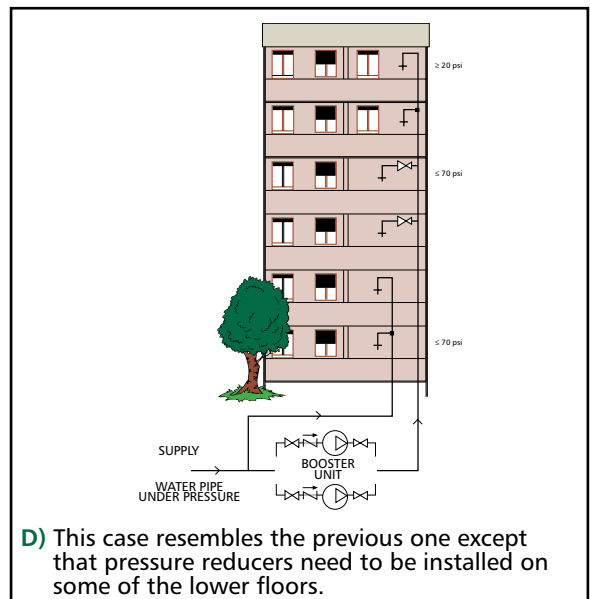
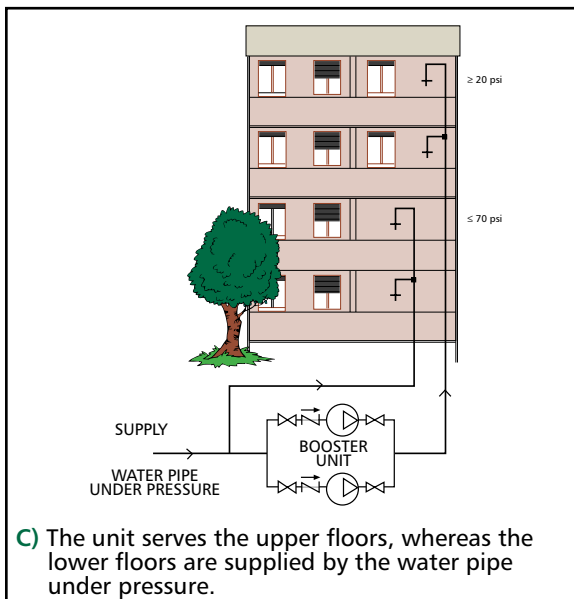
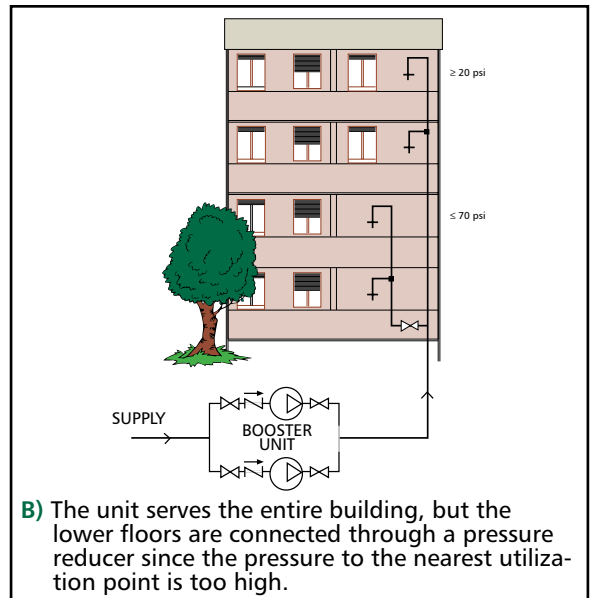
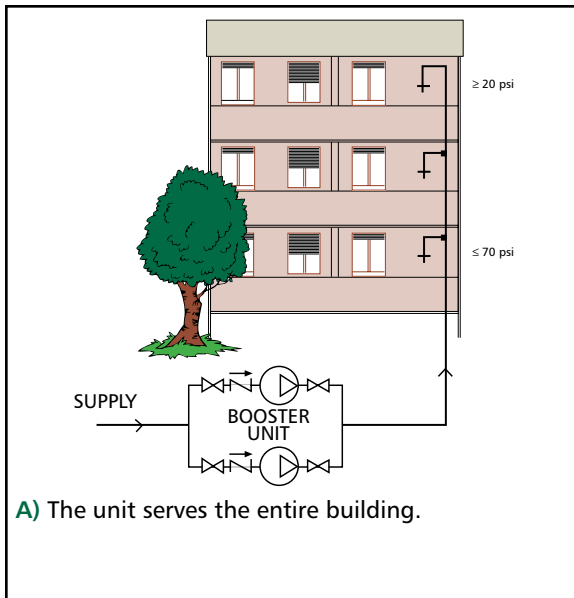



COMMON DESIGNS FOR BUILDING BOOSTER SYSTEMS

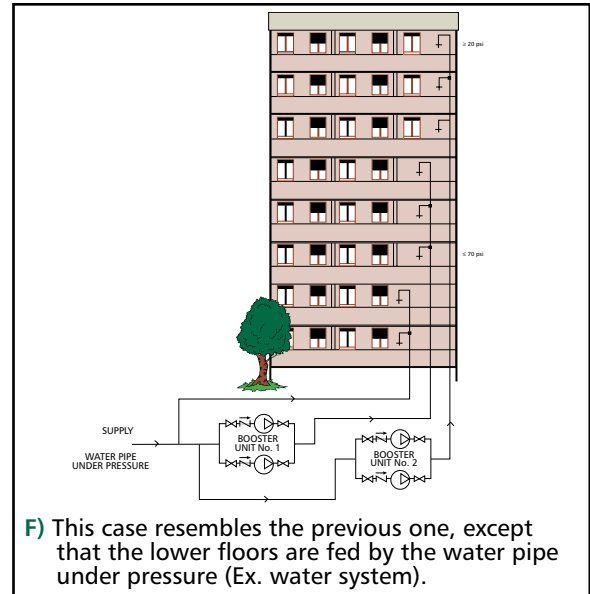
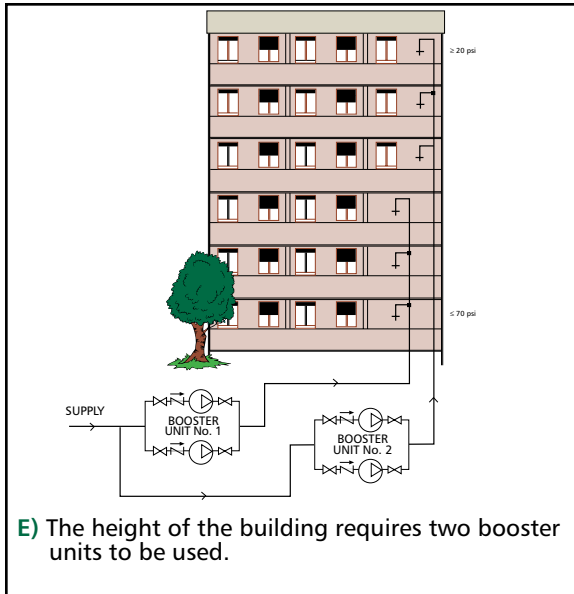

Calculating Total Dynamic Head

The Total Dynamic Head (TDH) for your booster application is calculated as follows:

$$TDH = H_e + H_r + H_c - H_s$$

Where:

- **He** is the vertical height difference between the booster discharge and the highest point of use.
- **Hr** is the friction losses of all of the piping, valves, elbows, etc. of the system.
- **Hc** is the desired discharge pressure at the top of the system.
- **Hs** is any suction pressure coming into the booster from the water supply line.

For details on calculating friction losses, see the tables in the technical data section of your G&L Pumps catalog or friction loss tables for piping.

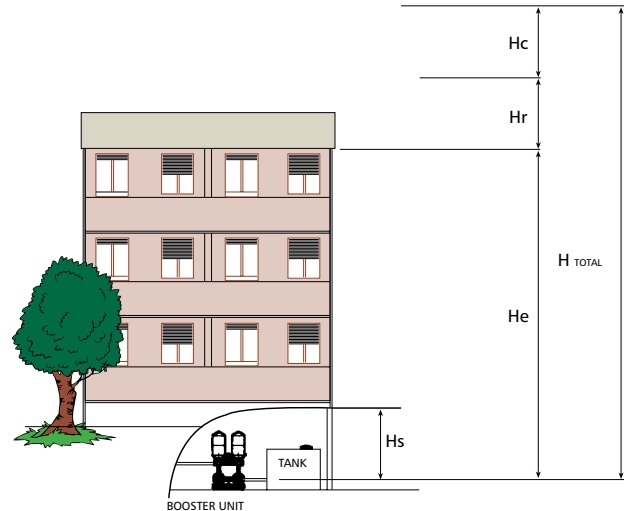

Example:

The highest tap in a building is 70 feet above the pump. Friction losses from piping add up to 30 feet, the user wants 50 psi (116 feet) available and there is 25 psi (58 feet) of suction pressure at the pump.

$$TDH = (H_e) + (H_r) + (H_c) - (H_s)$$

$$TDH = 70 + 30 + 116 - 58$$

$$TDH = 158 \text{ feet}$$



CALCULATING MAXIMUM FLOW RATES

In addition to determining the Total Dynamic Head required by your installation, you will also need to estimate the maximum flow rate required before you can select the correct pump station.

Two methods of estimating the maximum flow rate for different types of buildings are shown on this page. You can use the graph method if you know the number of apartments in an apartment house, the number of employees in offices or stores, or the number of beds in hospitals and hotels.

A somewhat more accurate method is to use the total number of plumbing fixtures in the building. If you can get a fairly accurate count of the total fixtures, you can use the chart on the bottom of the page to determine how much flow to allow for each fixture in the various types of buildings.

For example, in a hospital with 250 fixtures, the demand per fixture would be .50 gallons per minute or a total of 125 GPM for the hospital's booster system at peak demand.

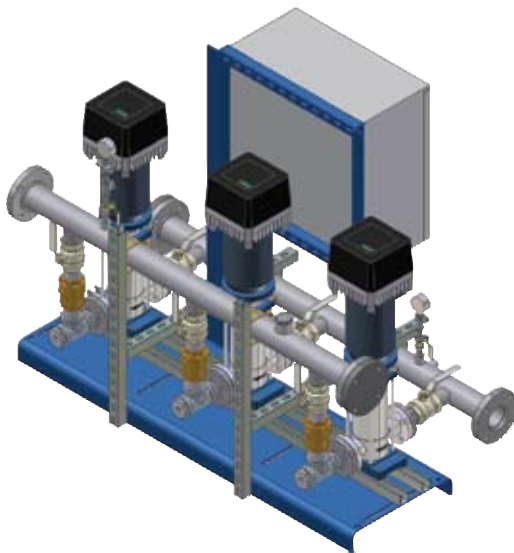
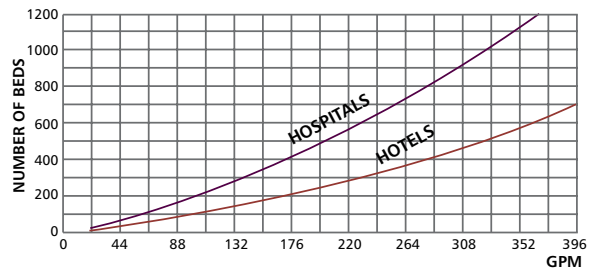
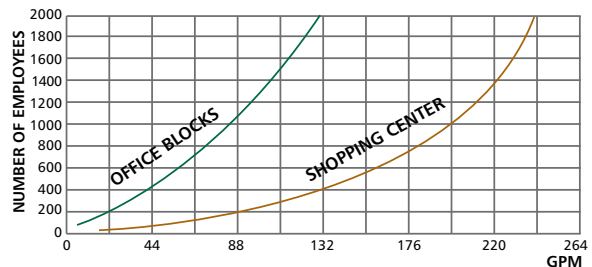
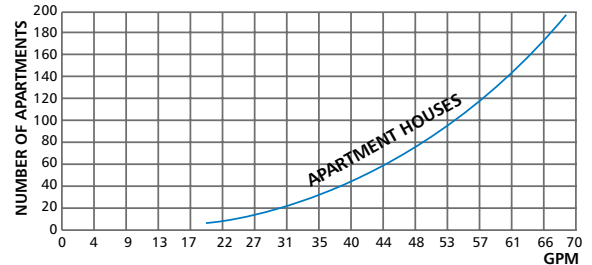

PUMP CAPACITY REQUIRED IN U.S. GALLONS PER MINUTE PER FIXTURE FOR PUBLIC BUILDINGS

Type of Building	Total Number of Fixtures						
	25 or Less	26 -50	51 -100	101 -200	201 -400	401 -600	Over 600
Hospitals	1.00	1.00	.80	.60	.50	.45	.40
Mercantile Buildings	1.30	1.00	.80	.71	.60	.54	.48
Office Buildings	1.20	.90	.72	.65	.50	.40	.35
Schools	1.20	.85	.65	.60	.55	.45	
Hotels, Motels	.80	.60	.55	.45	.40	.35	.33
Apartment Buildings	.60	.50	.37	.30	.28	.25	.24

1. For less than 25 fixtures, pump capacity should not be less than 75% of capacity required for 25 fixtures.
2. Where additional water is required for some special process, this should be added to pump capacity.
3. Where laundries or swimming pools are to be supplied, add approximately 10% to pump capacity for either.



ITT

GOULDS PUMPS
Commercial Water

SUGGESTED AquaForce SELECTION FOR CONSTANT PRESSURE OPERATION

Performance: Locate the pressure (TDH) you wish to maintain and the maximum flow you need. Select the pump which meets or exceeds this rating at full speed (the top line of the range curve). For multi-pump systems, the total capacity of all pumps should meet or exceed the total demand. Best results are obtained when the maximum pressure is within ten points of the best pump efficiency. This diagram can be used as a reference in selecting proper pump curves for operation with the AquaForce range curves shown below.

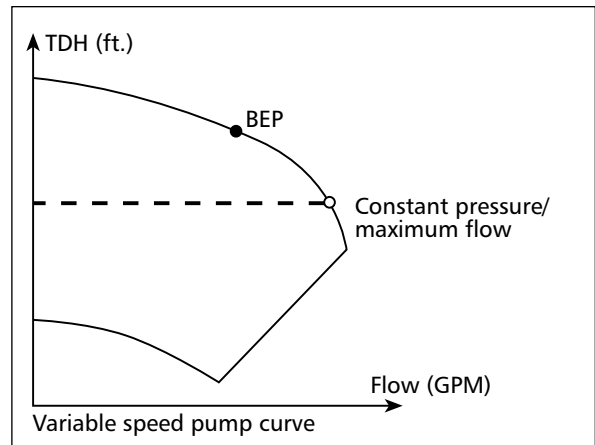

AquaForce Pumping Station Performance Range Curves

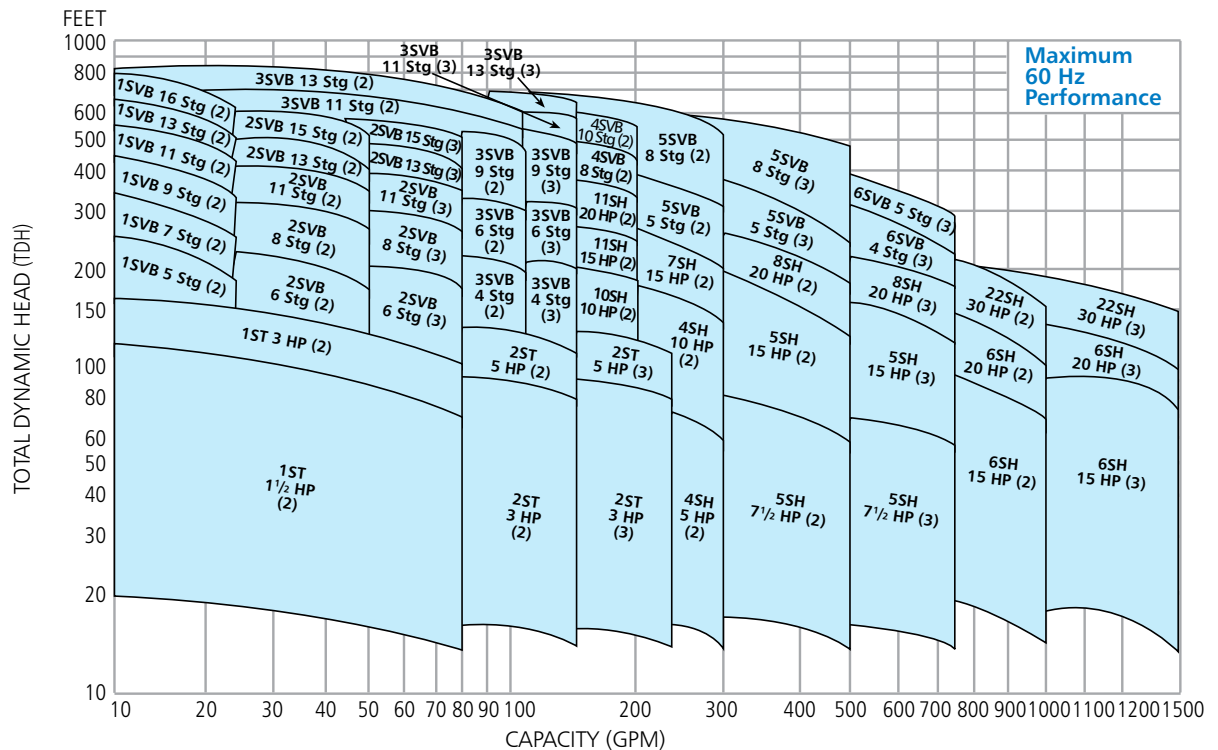

Note: Allow 10-15 feet TDH for friction losses within station piping or above range curves.

Note: Codes on chart refer to Goulds Pumps pump types, horsepower or stages. Numbers in parenthesis indicate number of pumps on that AquaForce station.



RECOMMENDED TANK SIZING

Overview

For smooth operation and shut-down at zero flow, it is recommended that a diaphragm or bladder type tank be sized for the AquaForce pumping system. The tank provides an air "cushion" to the system to ensure smooth operation, and prevent surges and oscillation of the discharge pressure. Also, it provides compressibility to the piping system at zero flow. When the pumps start ramping down, and approach zero flow, the capacity of the tank and the air pressure will ensure that the system shuts down when demand has stopped, thus providing compressibility to the piping system. Without a properly sized tank, it may make the system run longer or operate inconsistently.

When selecting the correct tank, make sure that the tank can support or exceed the maximum system pressures and meets the appropriate local codes for pressure ratings and potable water. The tank is not included from the Goulds Pumps factory, and must be supplied by others.

Size of Tank

Total capacity of the tank must be more than 10% of the maximum flow rate for one pump in the AquaForce™ pump station. Therefore, when you have a station that pumps a total of 1500 GPM with three pumps, look to see what one pump can produce in GPM at full speed. If that one pump can produce a maximum flow of 700 GPM, then it would be recommended that the sized capacity of the tank exceed 70 gallons. (NOTE: this is tank capacity, NOT drawdown gallons). This is the recommended size of the tank, and slightly larger tanks would work as well. Do not exceed more than 25 % of the total capacity of the largest pump in the system, for tank sizing. Doing so will cause longer delays and improper operation of the system. Remember, using a variable speed pumping system will allow the use of smaller tanks, which reduces cost and space requirements!

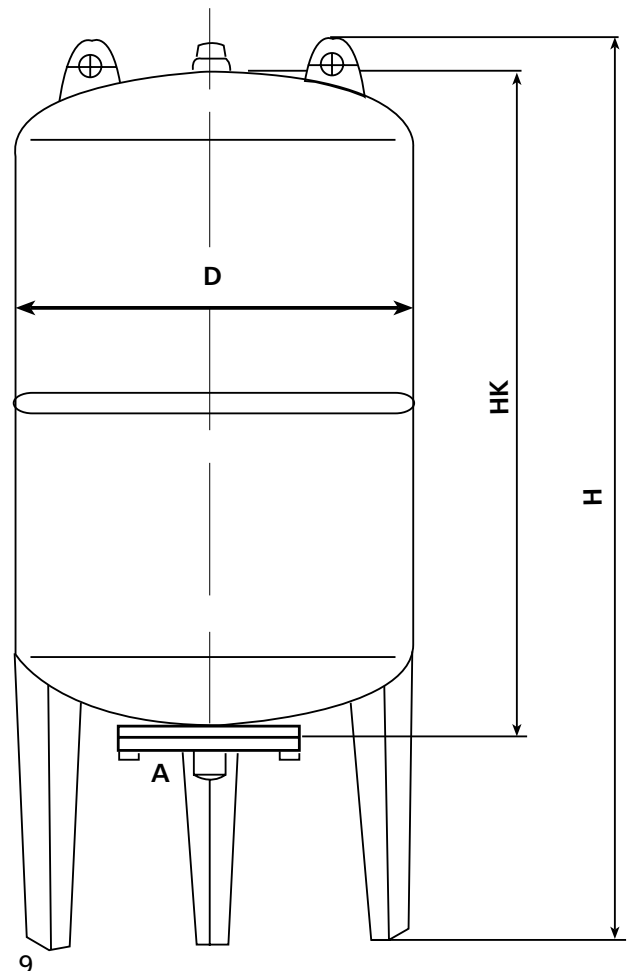



ITT

GOULDS PUMPS
Commercial Water

RECOMMENDED TANK SIZING

Tank Pressure

Now that the size (gallons) of the tank is determined, what pressure must be used in the tank? The tank should be pre-charged to approximately 10 – 12 psig below your system pressure. Therefore, if you had an AquaForce or Aquavar system, which was set to maintain 100 psig in your system, your tank would be charged to about 88 psig. Remember, that the tank is typically sent from the factory with little or no pressure, and a pre-charge will have to be performed at the site. When charging tanks, make sure that the maximum system pressure does not exceed the working pressure of the tank. For higher pressures, an ASME type tank may be needed for the system. Always follow tank manufacturers recommended procedures for pre-charge, mounting, piping. For accurate tank pressurization, be sure that there is no water in the system.

Tank Location

The tank should be located in the discharge piping downstream from the check valves. When the check valves close, you should have the tank and the transducers between the check valve and your shut-off valves in your discharge system. Make sure that the tank connection is the full pipe size recommended for the connection. Do not reduce or connect "quick disconnect" couplings to the tank, which will impede the flow from the tank during system operation. If shut-off valves are used before the tank, make sure that they are open for operation and system testing. It is important to make sure that no valves or other devices are between the transducers and tank.



AQUAVAR PUMP CONTROL

The AquaForce pump station comes complete with the Goulds Pumps Aquavar® or Aquavar II pump control mounted with each pump. The Aquavar is a pump specific variable speed controller which includes a control card, drive, communication circuit, transducer and protection circuits in one compact package. It is completely self contained with only a circuit breaker required for full capability.

Although the Aquavar has broad programming capability for a wide range of pump applications the set up for your installation will be completed for you by your Goulds Pumps distributor or authorized contractor. Once complete, about the only thing you will need to learn is how to turn the units off and on, set the required pressure and view the error menu.

Each Aquavar has its own pressure transducer and is connected to the other Aquavars in the system via an RS485 connection. In operation, the Aquavar constantly compares the transducer reading from the discharge line to the required pressure set point. When there is a drop in pressure, the Aquavar turns on the pump and gradually ramps up the motor speed until

the required pressure is being maintained. If the first pump reaches 60 Hz and the pressure is still not at the set point, a signal is automatically sent to the next Aquavar, which turns on the second pump. This continues until the set point is reached. If the set point is not reached with all pumps in operation (due to a broken discharge pipe for example) the Aquavars will automatically shut down after a time limit you select.

When there is reduced demand, the last pump to be started will gradually ramp down in speed and if pressure is still being maintained, will turn off. This will continue until all pumps are off in a no demand condition. This cyclic starting and stopping of the pumps based on user demand is completely automatic and assures consistent water pressure at varying flow rates. The Aquavar will also automatically change the lead pump at predetermined intervals to assure uniform pump use and wear. The following chart shows the pump speed and sequencing changes as demand increases at a set pressure requirement.

OPERATING CURVES

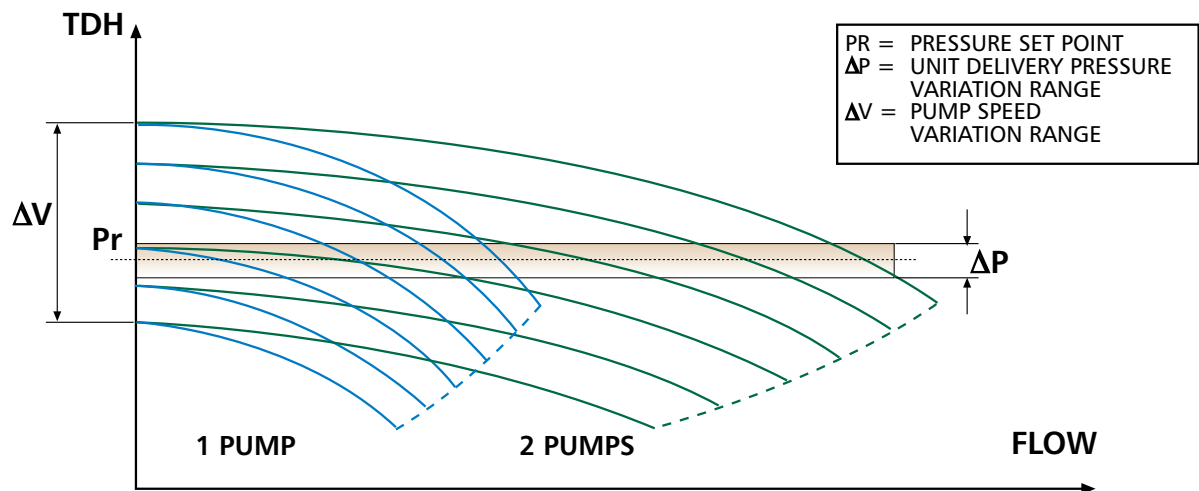

PUMP START: controlled through the corresponding transducer once the minimum operating value is reached.
PUMP STOP: controlled through the corresponding transducer once the maximum operating value is reached.

AquaForce



ITT

GOULDS PUMPS
Commercial Water

AQUAVAR PUMP CONTROL

In systems where high flow levels with higher friction losses are expected, the Aquavars can be programmed to automatically compensate for this by increasing speed and pressure at higher flows to match the system curve. This is shown below.

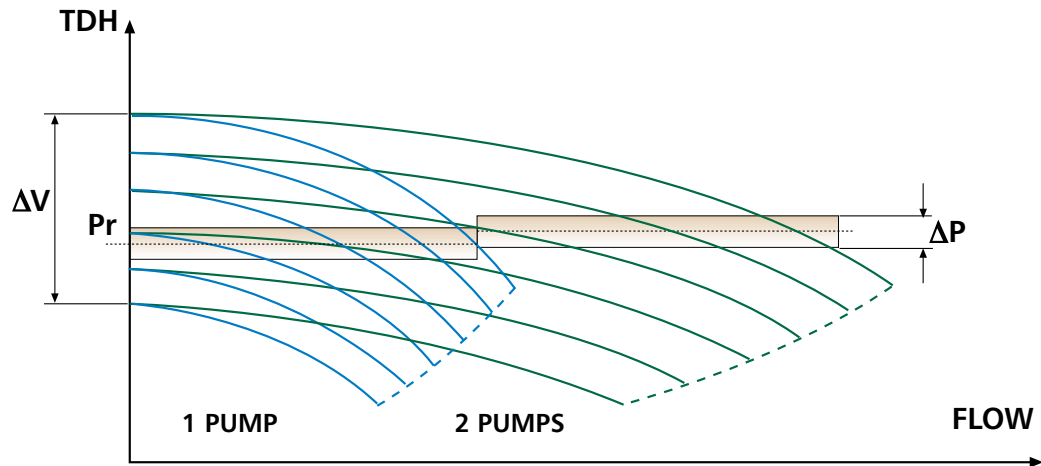





































Each Aquavar protects the pump against short circuit, ground fault, under voltage, over heating, overload, over voltage, motor over temperature, pump run out and dry run. Each Aquavar also displays when the inverter is on, when the pump is running and when there is a fault. These may also be connected to an optional alarm package. A lightning arrester is also available as an option for the entire pump station.



AQUAVAR SELECTION

The AquaForce Pump Stations are available with either the space and cost saving pump mounted Aquavar or the panel configured Aquavar CPC. Use the following chart to determine which is best for your application.

Aquavar Pump Mount  Aquavar CPC

Motor Size	230V / 1Ø	230V / 3Ø	460V / 3Ø
Up to 2 Hp →	 	 	
3 Hp →	 	 	
5 Hp →	 	 	 
7½ Hp →	 	 	 
10 Hp →	 	 	 
15 Hp →			 
20 Hp →			 
25 Hp →			 
30 Hp →			 

NOTE: Aquavar CPC is available up to 100 HP, 3Ø, 230V or 550 HP, 3Ø, 460V.

Aquavar Communications

The following signals are available on each Aquavar as standard equipment:

- RS485 - signal to other Aquavars or optional modbus interface.
- Pump running signal - dry contact.
- Fault signal - dry contact.
- Current pressure reading or running frequency - 0-10V analog.
- Connection for remote on/off.
- Multiple digital inputs.
- Analog outputs.

As listed, a modbus interface is available for the Aquavar. On the AquaForce station, one interface card communicates to all pumps.

For more specific information on the Aquavar or Aquavar CPC products, please refer to the Goulds Pumps bulletin, GLAQUA2.



ITT

GOULDS PUMPS
Commercial Water

AquaForce MAJOR COMPONENTS

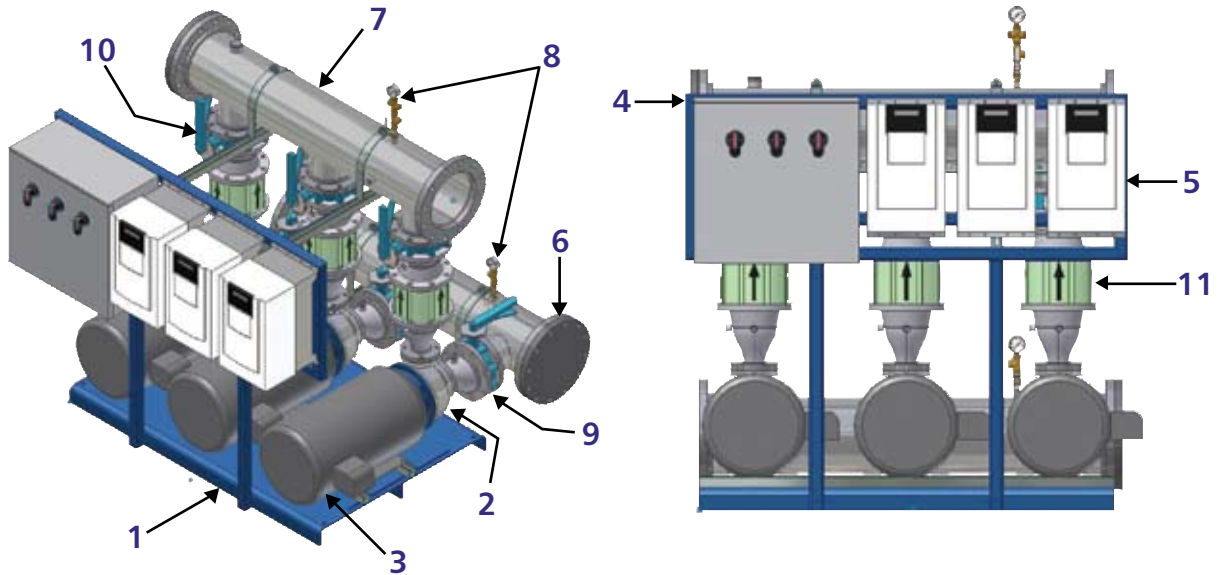

1. **(BASE)** Flat steel construction with supporting rib.
2. **(PUMP)** 316L stainless steel construction, end suction or vertical multi-stage.
3. **(MOTOR)** Standard NEMA design, Class F, Baldor® or equal, JM or TC frame.
4. **(MAIN FUSE DISCONNECT)** NEMA 4 enclosure, lock out for each pump.
5. **(AQUAVAR CONTROLLER)** Goulds Pumps variable speed controller (motor or panel mounted).
6. **(FLANGED SUCTION MANIFOLD)** ANSI removable flanges, 304 stainless.
7. **(FLANGED DISCHARGE MANIFOLD)** ANSI removable flanges, 304 stainless.
8. **(PRESSURE GAUGES)** Liquid filled 2½" diameter, bourdon tube type, WIKA® or equal.
9. **(ISOLATION VALVES)** Wafer type, low loss, Watts® or equal.
10. **(DISCHARGE ISOLATION VALVE)** Wafer type, low loss type, Watts or equal.
11. **(CHECK VALVES)** Non-slam, silent type, Watts or equal.

NOTE: Specifications/equipment subject to change without notice. Verify with factory.



ITT

GOULDS PUMPS Commercial Water

NOTES AND TYPICAL INSTALLATIONS



NOTICE: Information contained within this booklet, is based upon generally accepted engineering principles and data. However, it is the individual designer, engineer or architect's responsibility to make certain that the final design conforms to all applicable federal, state and local codes.



ITT

Commercial Water

AquaForce FEATURES AND SPECIFICATIONS

- ⇒ All systems are UL rated and run tested.
- ⇒ Maximum footprint, on most sizes, allow systems to fit through standard doorways.
- ⇒ 200 – 230 Volt single phase 1 – 10 HP, 200 – 230 Volt three phase 1 – 20 HP, 460 Volt 1 – 30 HP.
- ⇒ Each system is fabricated with Goulds Pumps horizontal or vertical multi-stage stainless and cast iron centrifugal pumps with a variety of electrical and mechanical options to choose from.
- ⇒ Standard “off the shelf” motors by Baldor or USEM Motors.
- ⇒ Significant reduction in energy consumption over fixed speed systems.
- ⇒ System protection from overvoltage, under-voltage, blocked suction, cavitation, NPSHa, phase loss, short circuit, transducer failure, and motor overload.
- ⇒ Liquid temperatures up to 212° F.
- ⇒ Ambient temperatures up to 120° F.
- ⇒ Maximum operating pressures up to 200 psi.
- ⇒ Pump run-out protection.
- ⇒ Dry running protection.
- ⇒ Programmable lead/ lag alternation.
- ⇒ Programmable system curve/ friction loss compensation.
- ⇒ Programmable system pressure starting.
- ⇒ Fault detection and alarms relay.
- ⇒ Motor run relay.
- ⇒ Programmable soft start.
- ⇒ 304 Stainless steel piping.
- ⇒ Bronze-fitted, isolation valves.
- ⇒ Optional suction / low pressure switch.
- ⇒ Optional pressure relief valves and temperature relief valves.
- ⇒ Optional lightning protection.
- ⇒ Optional flexible discharge hose.



 **GOULDS PUMPS**

BRAQFOR June, 2007

© 2007 ITT Corporation

Engineered for life

Goulds Pumps, Aquavar, AquaBoost, AquaForce and the ITT Engineered Blocks Symbol are registered trademarks and tradenames of ITT Corporation.

WIKA is a registered trademark of WIKA Instrument Corporation.

WATTS Regulator is a registered trademark of WATTS Industry Incorporated.

Baldor is a registered trademark of Baldor Electric Company.

SPECIFICATIONS ARE SUBJECT TO CHANGE WITHOUT NOTICE.